

BetaProbe TI/TI+

*High Accuracy
Digital Thermometer*

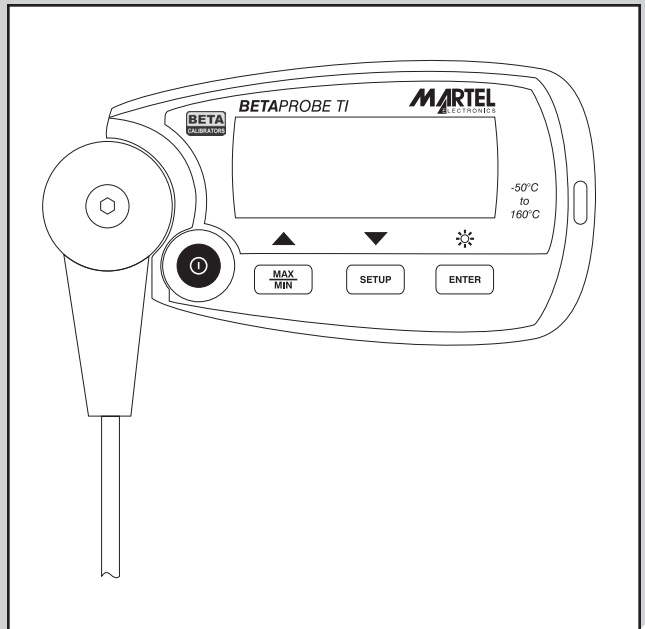

User Reference Manual

MARTEL
ELECTRONICS

1. Introduction

The BetaProbe TI/TI+ is designed to be a high precision digital thermometer that can be used in place of mercury liquid in glass (LIG) thermometers. It can also be used as a reference standard to check the accuracy of other types of digital or analog thermometers. Because of its intrinsically safe certification it can be used in many of the same hazardous locations as analog thermometers.

The probe houses a fast responding thin film (TI) or wire wound (TI+) sensor that allows very accurate readings to be taken quickly and with minimal insertion depth.

A rotatable probe mount allows for both horizontal and vertical orientation of the display module.

A unique feature of the BetaProbe TI/TI+ is the trend indication arrows which the user can configure to show when the readings are considered to be stable enough to record the reading.

Additional features such as min/max storage, selectable sample rate, auto-shutoff, backlight and damping allow the user to tailor the TI/TI+ for their specific application.

Battery life is up to 300 hours. With the auto-shutoff feature the typical user may only have to change the batteries a few times per year.

1.1 Customer Service

Corporate Office:

www.martelcalibrators.com

e-mail: sales@martelcorp.com

Tel: (603) 434-1433 800-821-0023 Fax: (603) 434-1653

Martel Electronics

3 Corporate Park Drive
Derry, NH 03038

1.2 Standard Equipment









Check that your BetaProbe TI/TI+ has arrived intact. Batteries are factory installed. Save the packing materials at least until you have verified that there is no concealed damage.

1.3 Safety information

A Warning identifies conditions and actions that pose hazard(s) to the user; a Caution identifies conditions and actions that may damage the Calibrator or the equipment under test.

Symbols Used

The following table lists the International Electrical Symbols. Some or all of these symbols may be used on the instrument or in this manual.

Symbol	Description
	Power OFF
	Power ON
	Earth ground
	Risk of Danger. Important information. Refer to manual.
	Battery
	Hazardous Voltage
	Conforms to ATEX requirements
	Conforms to relevant European Union directives.
	Wheeled bin, conforms to EC directive 2002/96/EC

Hazard Location Information/Approvals



An Ex-hazardous area as used in this manual refers to an area made hazardous by the potential presence of flammable or explosive vapors. These areas are also referred to as hazardous locations.



Ex ib IIB T4 Gb ($-10^{\circ}\text{C} \leq T_a \leq +50^{\circ}\text{C}$)
ITS10ATEX27114X
Ex ib IIB T4 Gb

II 2 G IECEx ITS10.0049X



0344

Manufactured by Martel Electronics, Inc.,
3 Corporate Park Dr.
Derry, NH, USA

This unit was designed to meet the above requirements using:

EN 60079-0:2006 ELECTRICAL APPARATUS FOR
EXPLOSIVE GAS ATMOSPHERES -- PART
0: GENERAL REQUIREMENTS (IEC
60079-0:2004 (MOD))

EN 60079-11:2007
EXPLOSIVE ATMOSPHERES -- PART 11:
EQUIPMENT PROTECTION BY INTRINSIC
SAFETY "I" (IEC 60079-11:2006 (EQV) +
CORRIGENDUM DEC. 2006 (EQV))

Special Conditions for Safe Use:

Misuse

Should the BetaProbe TI/TI+ be overheated or exposed to sudden physical shock (i.e. being dropped) it should be examined for any damage that may cause a safety concern. If in doubt please return the unit for evaluation to Martel Electronics. Please refer to the Customer Service Section for contact information.

WARNING

Check for proper operation of the instrument before taking it into a hazardous area. Should the instrument not operate as expected do not take the instrument into a hazardous area and return it to the manufacturer for inspection.

WARNING

The BetaProbe TI/TI+ is intended for installation only in locations providing adequate protection against the entry of solid foreign objects or water capable of impairing safety.

Caution

To avoid possible damage to calibrator or to equipment under test:

If the message changes to "OL" the range limit is exceeded and the BetaProbe TI/TI+ must immediately be removed from the heat source to prevent damage.

2. BetaProbe TI/TI+ Display and Controls

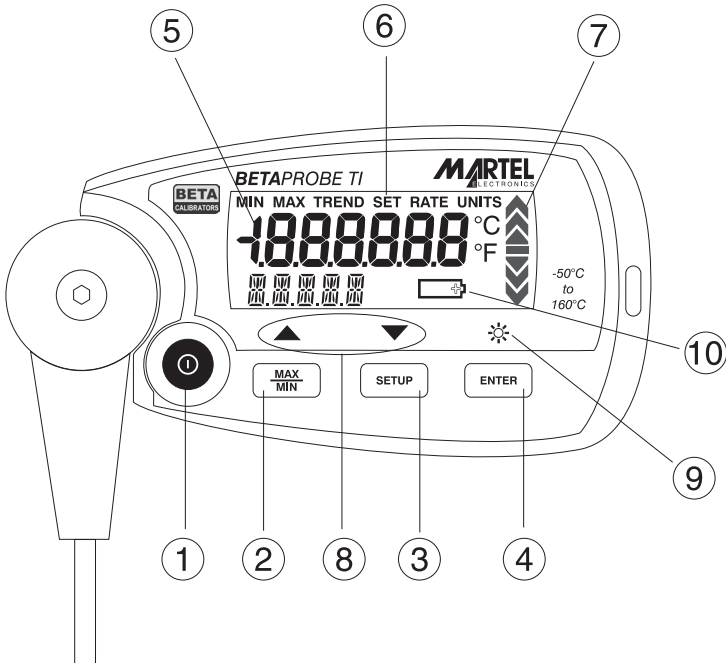

Item	Description
1 Power Key	Used to turn the unit on and off
2 Min/Max Key	Used to toggle the main display value between min, max, and trend modes
3 Setup Key	Used to change the various set-up parameters of the unit
4 Enter Key	Used to enter data in set-up modes
5 Primary Display	Used to display the temperature values in °C or °F. Also used in set-up mode.
6 Icon Area	Used in regular and setup modes
7 Stability Display	Used to show the trend and stability of data.
8 Arrow Keys	Secondary functions of the MAX/MIN and SETUP keys. Used for data entry in the setup modes.
9 Backlight Key	Secondary function of the ENTER key, turns backlight on or off.
10 Low Battery Display	Flashes when the battery needs to be changed.

3. Operation

Insertion Depth and Usage

The BetaProbe TI/TI+ should be inserted to a minimum depth of 2.5" to obtain specified accuracy of measurement. The final 2 inches of the probe should always be exposed to prevent high temperatures from damaging the instrument's electronics or housing. See illustration below.

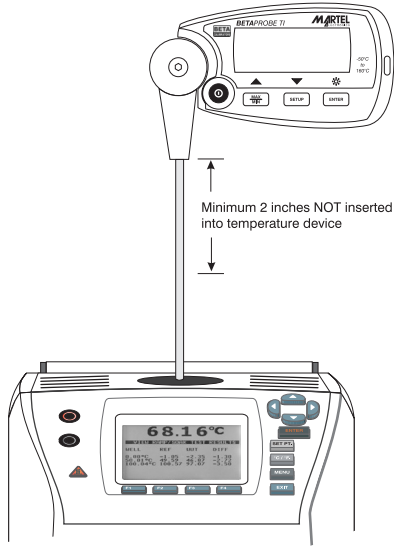

For best results, allow ample time for the probe to stabilize before recording measurements. The stability display is helpful for this.

Power

Push the power button momentarily to turn the unit on or off.

Normal Operation

Controlling the Backlight

Press the enter button to turn the backlight on or off.

Controlling the Primary Data Display

Use the MIN/MAX key to toggle the numeric display between the current reading, minimum, maximum and 1 minute trend values in either °C or °F as calculated since power up or since the last reset of the values. Press and hold the Min/Max key for 2 seconds until "CLR" is displayed to reset the MIN/MAX/TREND values.

Stability Display

The stability display shows the general stability level relative to a user configurable stability limit. There are 4 preset settings for stability represented in °C or °F (0.01, 0.1, 1.0, or 10.0). When the limit is exceeded, it also shows the general direction in which the readings are presently moving. The stability level is calculated from a moving sample window of six seconds duration, with the value extrapolated to a 1 minute time base.

Segments are turned on to indicate the stability level as follows:

- Center only (stable) when half of the 1 minute trend value is less than or equal to the stability limit, i.e. maximum deviation –limit to +limit.
- Center plus one arrow up or down (depending on the trend) when half of the 1 minute trend value is greater than the stability limit and is less than or equal to twice the stability limit.
- Center plus two arrows up or down (depending on the trend) when half of the 1 minute trend value is greater than twice the stability limit and is less than or equal to three times the stability limit.
- Center plus three arrows up or down (depending on the trend) when half of the 1 minute trend value is greater than three times the stability limit.

Set-up and Configuration

Use the set-up key to enter the setup modes. Inside the setup modes the keys work as described below.

MAX/MIN Exit to the main display.

SETUP Step to the next menu item, exiting to the main display after the last item.

ENTER Enter the data edit mode for the present menu item.

During the data edit mode, use the ▲ and ▼ keys to scroll through the values. Use ENTER to exit back to the menu item.

The following paragraphs describe the set-up items in the order in which they appear.

Temperature Unit Selection

The Temperature Unit Selection menu allows the user to chose the unit used when displaying the primary variable.

▲ Change the unit °C or °F.

▼ Change the unit °C or °F.

ENTER Exit back to menu item

Stability Limit

The stability limit setting is used to determine when the secondary display will indicate that the reading is stable. There are 4 preset settings for stability (0.01, 0.1, 1.0, or 10.0) expressed in the presently selected units.

- ▲ Change the unit stability limit setting to the next greater setting.
- ▼ Change the unit stability limit setting to the next lesser setting.

ENTER Exit back to menu item

Auto Off Selection

The Auto Off parameters control when the unit automatically turns off after inactivity on the keypad.

- ▲ Increase the auto off setting and the primary data field, advancing from "OFF" to 1 minute and stopping at 30 minutes.
- ▼ Decrease the auto off setting and the primary data field, advancing from 1 minute to "OFF" and stopping at "OFF".

ENTER Exit back to menu item

Battery Life

Initially the primary data field shows the percentage of battery life that is remaining. This display can be toggled to show the battery voltage. This display is updated continually to reflect the present battery capacity.

Press the ENTER key to toggle between the two data displays.

Operating Temperature

This selection shows the operating temperature of the unit head in °C or °F.

- ▲ Change the unit °C or °F.
- ▼ Change the unit °C or °F.

ENTER Exit back to menu item

Note: Should the head temperature rise above 50°C (122°F) an "Overtemp" warning will be displayed.

Damping

The Damping function is a running average of readings used filter out "noisy" temperature sources. The choices are OFF, 2, 5, or 10 sample average.

- ▲ Change the damp setting to the next item in the list, cycling from the last to the first.
 - ▼ Change the damp the previous item in the list, cycling from the first to the last.
- ENTER Exit back to menu item

Sampling Rate

The sampling rate determines how often the Beta Probe samples data. The settings are (0.5, 1.0, or 2.0), expressed in samples per second.

- ▲ Change the rate setting to the next item in the list, cycling from the last to the first.
 - ▼ Change the rate setting to the previous item in the list, cycling from the first to the last.
- ENTER Exit back to menu item.

Display Resolution

Display resolution is the number of digits to the right of the decimal point. The settings are (0.1, 0.01, or 0.001).

- ▲ Change the resolution setting to the next item in the list, cycling from the last to the first.
 - ▼ Change the resolution setting to the previous item in the list, cycling from the first to the last.
- ENTER Exit back to menu item.

RS232 Communication

The baud rate can be set to 2400 or 9600.

- ▲ Change the RS232 communication setting in the list, cycling from the last to the first.
 - ▼ Change the RS232 communication setting to the previous item in the list, cycling from the first to the last.
- ENTER Exit back to menu item.

Note: The following Data Logging functions can only be enabled with the optional BetaLOG-TI program which is available from Martel or your Martel distributor. Detailed information on the Logging functions is included with the BetaLOG software.

Start or Stop Data Logging

The logging status shows "FULL" if the data logging memory is full, "OFF" if not presently logging data, or "ON" if presently logging data. Pressing ENTER allows you to change the logging status.

▲ or ▼ If not presently logging data, choose between "START" and "OFF". If presently logging data, choose between "STOP" and "ON". The present data logging mode is not changed until the ENTER key is pressed.

ENTER Stop or Start data logging

Display Free Log Memory

Initially the primary data field shows the percentage of log memory. This display can be toggled to show the number of free records. This display is updated continually during data logging to reflect the present memory capacity.

Press the ENTER key to toggle between the two data displays.

Logging Interval

The ENTER key is ignored if presently logging data.

Otherwise, when the ENTER key is pressed to enter the data edit mode.

▲ Change the logging interval setting to the next item in the list, cycling from the last to the first.

▼ Change the logging interval setting to the previous item in the list, cycling from the first to the last.

ENTER return to the corresponding menu item.

Send Logged Data

The ENTER key is ignored if presently logging data.

Otherwise, when the ENTER key is pressed, the user is allowed to:

▲ or ▼ Confirm or cancel the choice to send data.

ENTER Send or cancel data.

Erase Logged Data

The ENTER key is ignored if the presently logging data.

Otherwise, when the ENTER key is pressed, the user is allowed to:

▲ or ▼ Confirm or cancel the choice to erase logged data.

ENTER Erase or cancel data erase.

4. Changing the Batteries



WARNING



Explosion hazard

Batteries must only be changed in an area known to be non-hazardous.

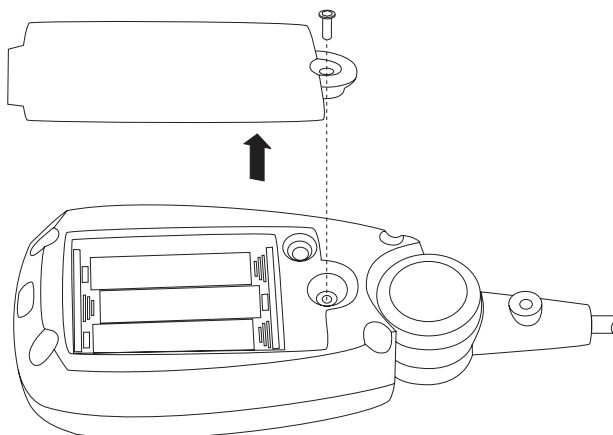

Remove the battery door to expose the three AAA batteries. Replace only with AAA batteries approved in this document. Replace the battery door and reinstall the hex screw. Be sure to use only the approved list of batteries. Any substitution will void the safety ratings of this product.

Battery	Manufacturer	Type
Alkaline AAA	Duracell	LR03/MN2400
Alkaline AAA	Rayovac	LR03/824
Alkaline AAA	Energizer	LR03/E92
Alkaline AAA	Panasonic	LR03X

Battery life

Battery life is about 300 hours (12.5 days) of continuous use with the backlight off. There is a low battery icon in the lower right of the display. It will appear when battery level is low. Replace batteries per recommendations found in the specifications section of this manual.

RS-232 Interface

An RS-232 interface is standard on the BetaProbe TI/TI+. Serial communication can be used for configuration, calibration, and to transfer measurement data from the probe. When the data logging software is purchased, a RS-232 and USB cable is included. For customers wishing to do calibration only the RS-232 cable is available from Martel. Order P/N 1919069.



The RS-232 interface must not be used in hazardous areas.

5. Cleaning

To clean the BetaProbe TI/TI+ use a cloth with a mild cleaning solution.

6. Calibration

The BetaProbe TI/TI+ can be calibrated in the field by one of three methods depending on the extent of the calibration needed.

- 1) Single point Ro calibration (typically 0C)
- 2) Two-Point calibration Ro and gain (typically 100C).
- 3) A full 4 point calibration.

For complete calibration instructions please contact Martel Electronics Corp. **www.martelcalibrators.com**

7. Specifications (23 ± 5°C unless noted)

Measurement Range:

BetaProbe TI: -50°C to 160°C (-58°F to 320°F)

BetaProbe TI+: -50°C to 300°C (-58°F to 572°F)

Accuracy (1 year):

± 0.06°C (0.1°F)

Resolution:

Selectable (0.1, 0.01, 0.001) factory default is 0.001

Sample Rate:

User selectable 0.5/sec, 1/sec or 2/sec factory default is 1/sec

Operating Temperature Range of Readout:

-10°C to 50°C

EMC Compliance:

EN61326:2006 Annex C

CISPR II, Edition 5.0-2009

Class "B"

Humidity Range:

0 to 95% R.H. Non-condensing

Storage Temperature Range:

-20 to 60°C

Enclosure Rating:

IP50

Readout Temperature Coefficient:

Add ± 10ppm/°C of full scale temperature from -10°C to 18°C and 28°C to 50°C

Power:

3 AAA alkaline batteries

(Must use only approved batteries see section 4)

Battery Life:

Approximately 300 hours without back light

Battery Save (auto-off) Range:

Selectable from 1 to 30 minutes or can be disabled

Size (readout only):

Approximately 4"x2"x1"

Probe Size:

BetaProbe TI (1919876) 3/16" Diameter x 12" Length

BetaProbe TI (1919918) 3/16" Diameter x 18" Length

BetaProbe TI+ (1919877) 1/4" Diameter x 12" Length

Weight:

6.9oz.

8. Warranty

Martel Electronics Corporation warrants all products against material defects and workmanship for a period of twelve (12) months after the date of shipment. Problems or defects that arise from misuse or abuse of the instrument are not covered. This includes but is not limited to bent probes, broken cases, and blackened probe sheaths. If any product is to be returned, a "Return Material Authorization" form can be obtained from our website www.martelcorp.com under customer service. You can also call 1-800-821-0023 to have a form faxed. Martel will not be responsible for damage as a result of poor return packaging. Out of warranty repairs and recalibration will be subject to specific charges. Under no circumstances will Martel Electronics be liable for any device or circumstance beyond the value of the product.

WARNING

Substitution of components will impair suitability
for hazardous locations.



0219876 Rev. C 8/11

To order parts and items, go to www.Instrumentation.com or call (800) 346-4620